

MEWA

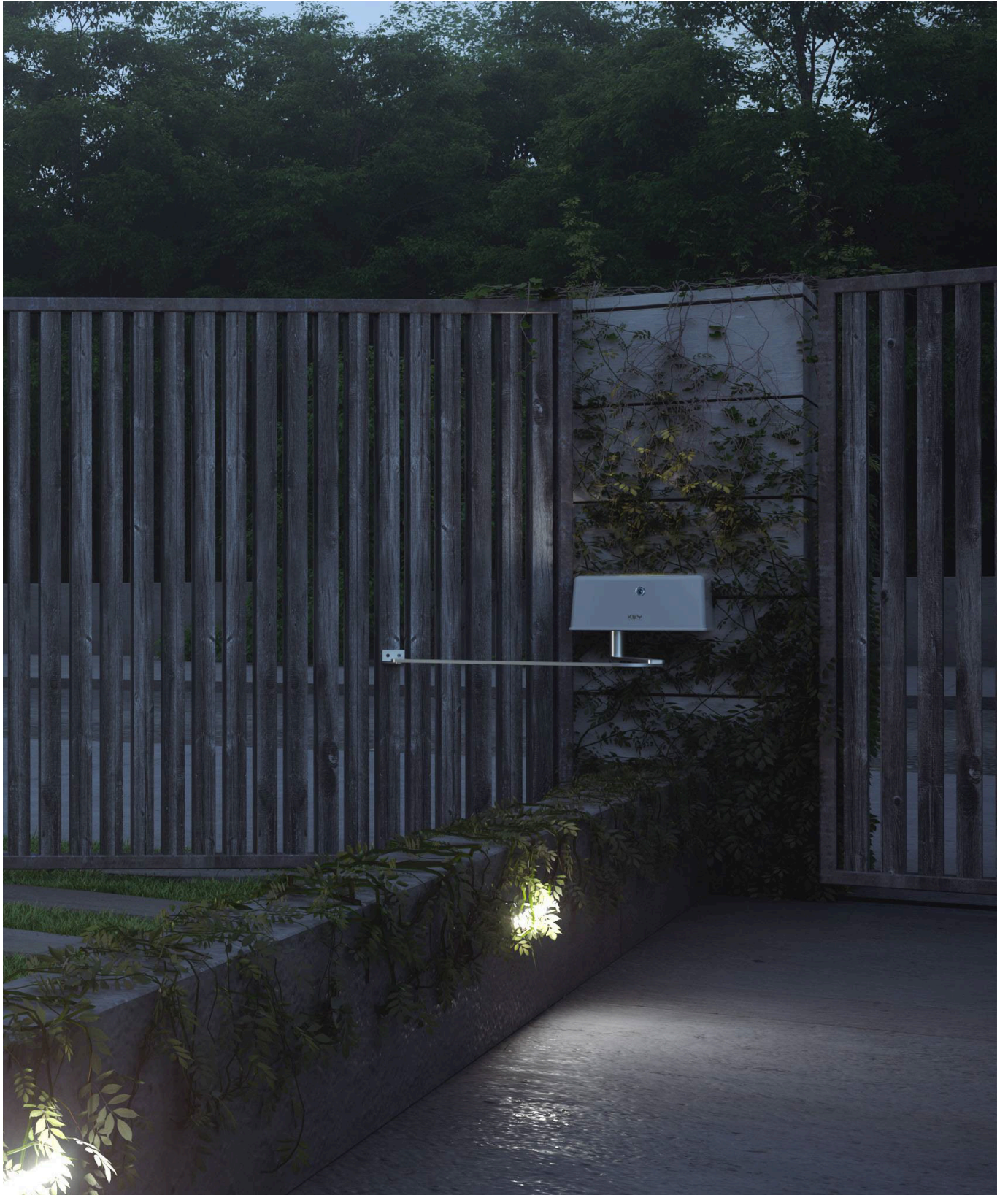

**ELECTROMECHANICAL GEAR MOTOR
WITH ARTICULATED ARMS FOR SWING
GATES**





External release for an easy manual unlock from outside

Powerful motor with solid metal gearbox

Limit switch with precision regulation

Reinforced and sturdy arm suitable for wide-angles opening

PROGRAMMING VIA SMARTPHONE

+ **KUBE and KUBE PRO** Optional programming with KUBE PRO wireless module (from FW version 2.0)



MODELS

CODE	DESCRIPTION
SN5024DX	RIGHT motor (view from inside) for swing gates with maximum length 3 m per leaf, 24 Vdc motor with encoder
SN5024SX	LEFT motor (view from inside) for swing gates with maximum length 3 m per leaf, 24 Vdc motor with encoder
KSN5024B	Pair of motors for swing gates with maximum length 3 m per leaf, 24 Vdc motor with encoder (2 pcs)

DIMENSIONS

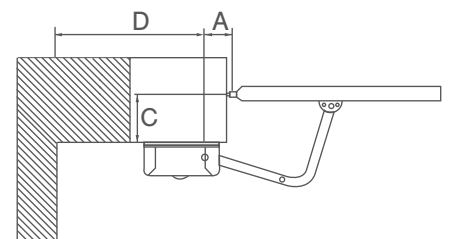
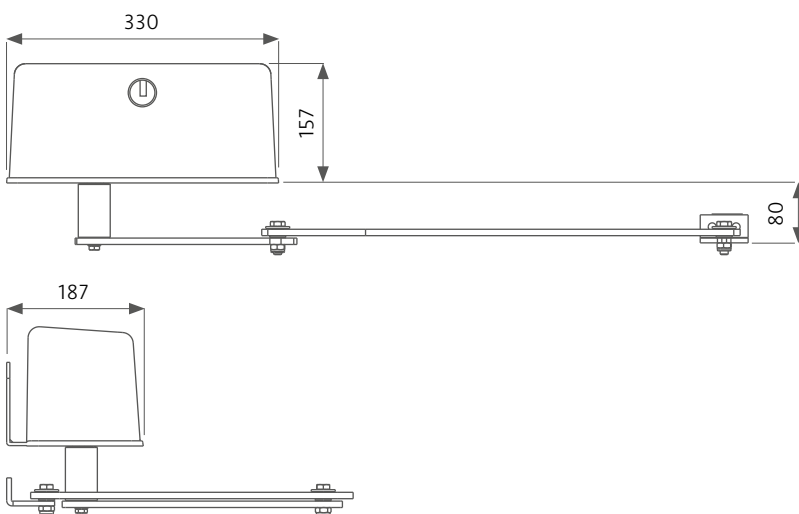

A min	150	
C max	300	450 *
D min	500	600 *

* with accessory **LEVA008A00**

TECHNICAL DATA

SN5024

MECHANICAL DATA

torque	Nm	350
working cycle	%	80
opening time at 90°	sec	15-25

ELECTRICAL DATA

control board		14AB2
power	Vac	-
	Vdc	24
consumption	A	5
absorbed power	W	120
capacitor	µF	-
thermoprotection	°C	-

GENERIC DATA





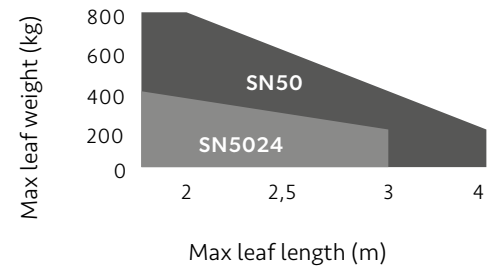



















protection degree	IP	43
dimensions (L - D - H)	mm	330 - 187 - 157
weight	kg cad	13,8
working temperature	°C	-20 + 55
leaves maximum weight	Kg	400

LIMIT USE



Gate shape and height and weather conditions can considerably reduce the values shown above, in the graph. 230 Vac motors are suggested for windy areas

ACCESSORIES

				
ELS-C 12 V horizontal electric lock. Up to 2000 Kg	BDBOC Telescopic arm for folding doors	SBLEXT Cable external release kit	KFE Kit electric limit switches for 24Vdc version	LEVA008A00 Articulated straight arm for columns from 301 to 450mm
				
SUB remotes Water and dust resistant 433MHz transmitters, rolling code	DYL Programming module Cable length 120 cm (only 14A board)	KUBE PRO Wireless module for programming	KUBE Wireless controlling module for end user	RX4K 4-channel plug-in receiver, 433MHz, for CT202 control unit
				
14AB2 Control unit for two motors 24 Vdc in box	FT43 Pair of photocells for external use adjustable through 180	FT43B Pair of photocells for external use adjustable through 180, battery version	FT33 Pair of photocells for external use, flush mounting	RP25K Reflective photocells
				
ECLIPSE Led flashing with courtesy light, crepuscular sensor and built-in antenna	SEL-R Wireless keypad transmitter, 433MHz	EGKTR1 Wireless keypad transmitter, EGO series 433MHz	TO1M 1-channel touch transmitter, rolling code 433Mhz	RXM23Y 2-channel universal receiver, fix or rolling code
				
KBP Kit of 1.3 Ah lead battery and battery charger	KSOLAU Solar kit, includes 30W panel, recharge unit in enclosure, mounting brackets and batteries	SPLIT24V Low Voltage box	EG100LA 100cm post with LED and houses accessories	STIKDD Outdoor lighting range, downward facing

* it is not recommended to use a connection longer than 4 m to avoid sensible loss of reach



KEY AUTOMATION AUSTRALIA

Unit 6 - 8 Cooper Street
Smithfield NSW 2164 AUSTRALIA
Ph. 1300 001 KEY - 1300 001 539
info@keyautomation.com.au
www.keyautomation.com.au



follow us:     