

TURBO 200

FOR SLIDING GATES UP TO 2500 KG, 230 VAC



The SC202MHD gearmotor now comes with an electro-mechanical brake as a standard

Aluminum polished base and raised fixing plate

Hidden external case fixing

With 230 Vac CT102B control unit with integrated display



COOLING FAN (SC202MHD) FOR INTENSIVE USE



STURDY AND PERFORMING MOTOR



ELECTRONIC AND MECHANICAL PARTS WELL PROTECTED FROM WEATHER CONDITIONS

TECHNICAL DATA

SC202MHD

MECHANICAL DATA

speed	cm/s	17
torque	Nm	93
working cycle	%	50/70*

ELECTRICAL DATA

control board		CT102I
power	Vac	230
consumption	A	4
absorbed power	W	920
capacitor	μF	25
thermoprotection	°C	150

GENERIC DATA

protection degree	IP	44
dimensions (L - D - H)	mm	360 - 270 - 390
weight	kg	24,8
working temperature	°C	-20 + 55
gate maximum weight	Kg	2000

DIMENSIONS

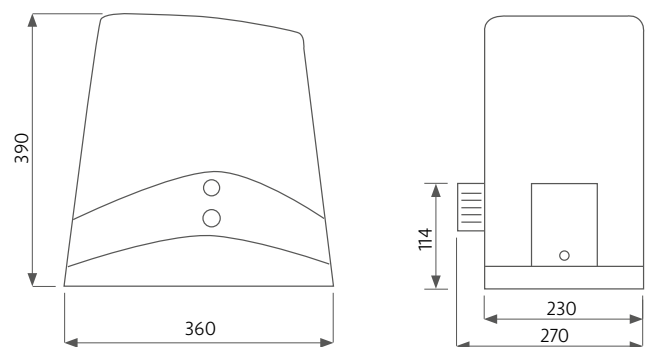

















* variable according to the gate weight and dimensions

MODELS

CODE	DESCRIPTION
SC202MHD	For sliding gates up to 2000 Kg, 230 Vac motor, control unit with magnetic limit switch and mechanical electro-brake. M4 pinion. Intensive use

ACCESSORIES

				
RUELO04A00 Pinion M6 Z12	CREM-12 * M4 zinc coated rack 30x12 mm L=1000 mm	CREM-30 ** M6 zinc coated rack 30x30 mm L=1000 mm	SC-EF Mechanical electro-brake (for SC252M)	RX4K 4-channel plug-in receiver, 433MHz, for CT202 control unit
PC1	PC1	PC1	PC1	PC1
				
RXM23Y 2-channel universal receiver, fix or rolling code	FT43 Pair of photocells for external use adjustable through 180	FT43B Pair of photocells for external use adjustable through 180, battery version	FT33 Pair of photocells for external use, flush mounting	RP25K Reflective photocells
PC1	PC1	PC1	PC1	PC1
				
ECLIPSE Led flashing with courtesy light, crepuscular sensor and built-in antenna	SEL-R Wireless keypad transmitter, 433MHz	EGKTR1 Wireless keypad transmitter, EGO series 433MHz	TO1M 1-channel touch transmitter, rolling code 433Mhz	KPLAY4R Kit with 2x 4-channel 433 MHz transmitters, rolling code
PC1	PC1	PC1	PC1	PC1
				
SUB remotes Water and dust resistant 433MHz transmitters, rolling code	EG50 500mm post for photocells			
PC1	PC1			